



ISIVS XL

INDUCTION SEALING INTEGRITY
VERIFICATION SYSTEM



Optomech ISIVS uses cutting edge infrared imaging technology
to inspect and reject induction sealed containers



A good induction seal prevents product leakage, is tamper proof, maintains product quality and fosters consumers' confidence. Primary packaging sealing integrity is crucial in ensuring product viability and shelf life.

The days of sampling as the primary means of inspection and analysis for quality control is nearing an end. Manufacturers are looking for 100% inspection of sealed containers, the ISIVS (Induction sealing integrity verification system) does non-destructive 100% inspection by using dynamic thermal imaging to inspect the integrity of induction sealed bottles.

Inspection is performed through closed bottle caps without damaging or degrading the product and without reducing line speed.



Operating Principal

When the induction sealed container passes through the ISIVS a highly sensitive cooled thermal camera images the heat profile of the seal. Advanced software algorithms are used to analyse the thermal image for detecting the defects. The defective containers are ejected from the line.

Salient features

- Extremely clear and sharp images using advanced cooled thermal imaging technology.
- Software complies with USFDA code of federal regulations (**Title 21 CFR part 11**).
- Any number of different products can be configured and stored directly by the user.
- Tolerances for the acceptance and rejection criteria can be set and saved in the database.
- Change over is simple process of just selecting the product from the list of the configured products.
- Remote online support is provided by Optomech for help in configuring new products.
- Multi level password protected user access control is provided.
- Large 17" industrial touch screen user interface.
- All parts are made with stainless steel.
- 2 way ejection mechanism to ensure no defective product is allowed to pass.
- Ejection bin is provided with level sensors.
- Feeding wheel integration is provided.

Setup

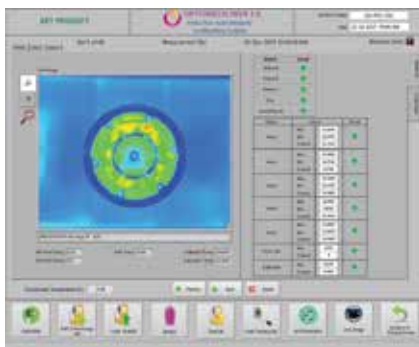

Results

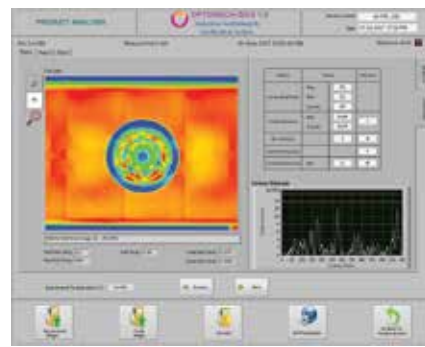

Reporting

- Inspection screen displays graphically the last 100 detected defects to enable you to discover and fix potential problems in real time.
- The photos of the defective bottles are stored, in the database, they can be recalled for review any time in future.
- All inspection data/results is stored in the database.
- Reports enable statistical process control of the induction sealing process over time.
- User access command log report can be generated.
- Reports can be generated in both PDF and Excel formats.
- System can be configured to automatically generate an Excel report at a predefined time, and send over the network.

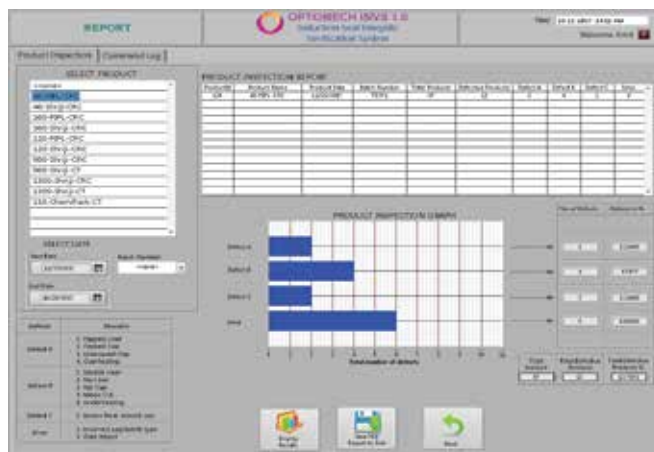

Typical Defects



Loose Cap

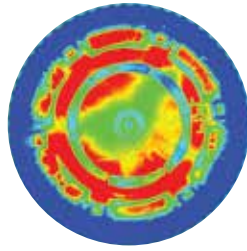

Under Heating



Over Heating

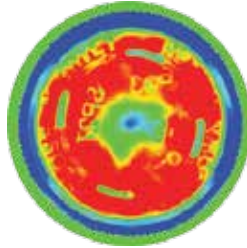

Cut Liner

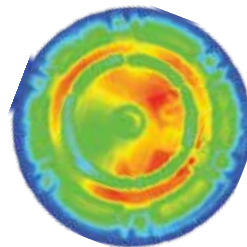

Moon Cut

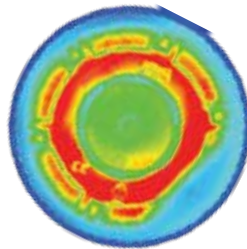

No Liner

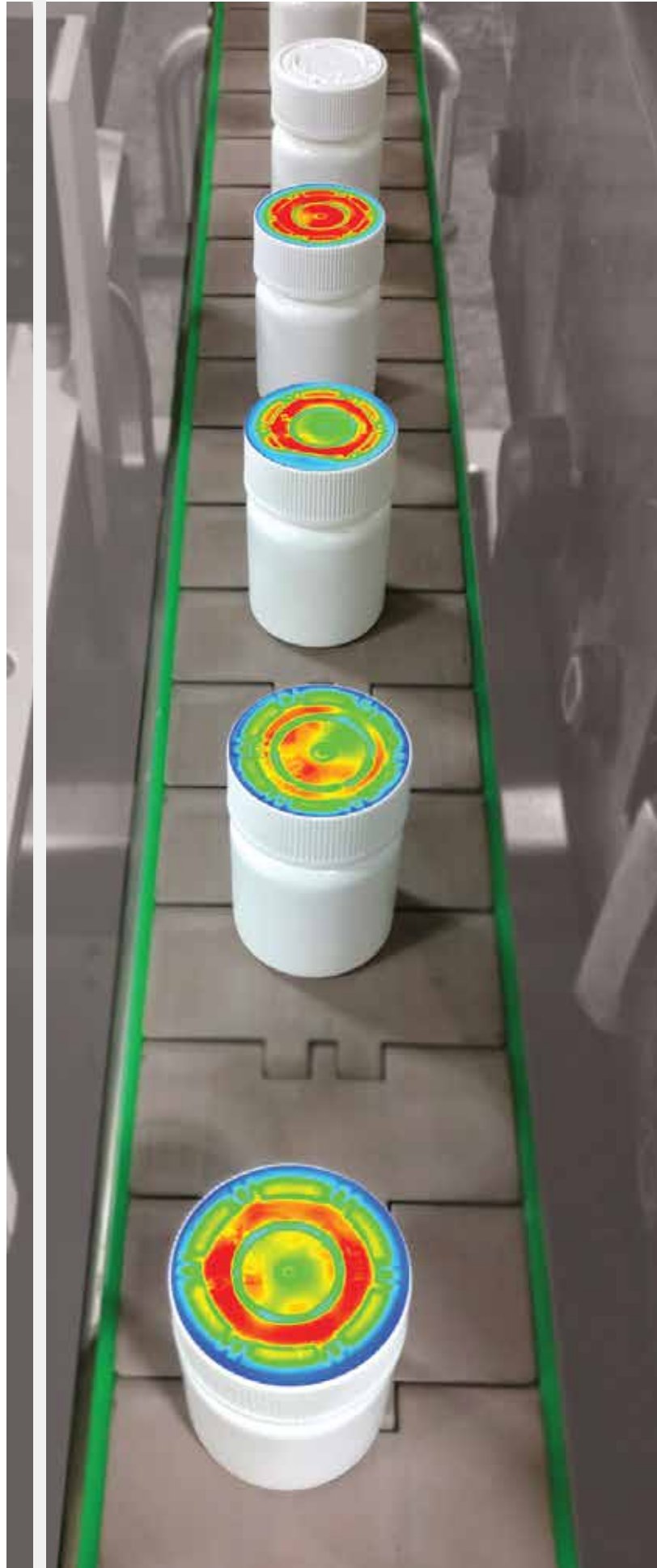



Optomech has a well equipped optical and mechanical design and fabrication facility at its works at Hyderabad which is ably supported by a team of motivated and trained engineers for installation, commissioning, training and after sales services of its equipments.

Optomech specializes in the development and manufacturing of quality control equipments based on optical and video imaging technologies.

Optomech Engineers Pvt. Ltd. was founded in Hyderabad, India in the year 1981.

Optomech has over 37 years of experience of successful development, manufacturing, servicing and marketing of products involving vision technology for quality inspection.

We are closely orientated towards the needs of the market. We are one of the leading providers of vision technologies for quality inspection. Renowned companies place their trust in the solutions and services provided by Optomech.

For us at Optomech, 'Professional After-Sales Service' is not just a simple catch phrase; instead, it is our company philosophy. We accompany you all the way from the initial consultation up to final installation and training – and beyond. You will benefit from our many years of experience and will be able to deal with the challenges encountered when implementing the new technology.

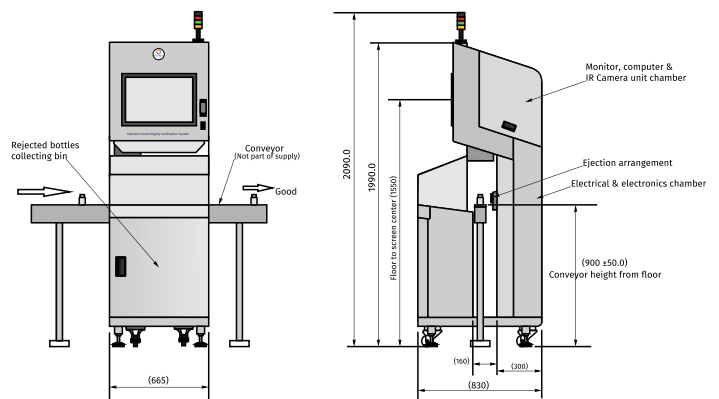

Model	Optomech induction sealing integrity verification system
Speed	250 bottles per minute
Applicable containers and caps	Bottle: height 250 mm, dia 125 mm, Volume 1300 cc Cap : diameter 110 mm
Machine Size	Length 830, Width 625, Height 2090 mm
Software	Complies with 21 CFR part 11
Qualification	IQ, OQ and PQ documentation will be provided
Utilities	Power AC 415 V, 3 Phase, 5A / Compressed Air: 6-10 bar
Operating Conditions	Temperature : +10° to +40°c Humidity : 40% to 90% RH Non Cond

Some of our esteemed customers



Optomech Engineers Pvt Ltd
3A Type II, I.E., Kukatpally, Hyderabad 500 072, Telengana India
Ph: +91 40 23078371 sales@optomech.in www.optomech.in

We reserve the right to modify the product specifications, in the interest of product development